

Konvision
www.konvision.com

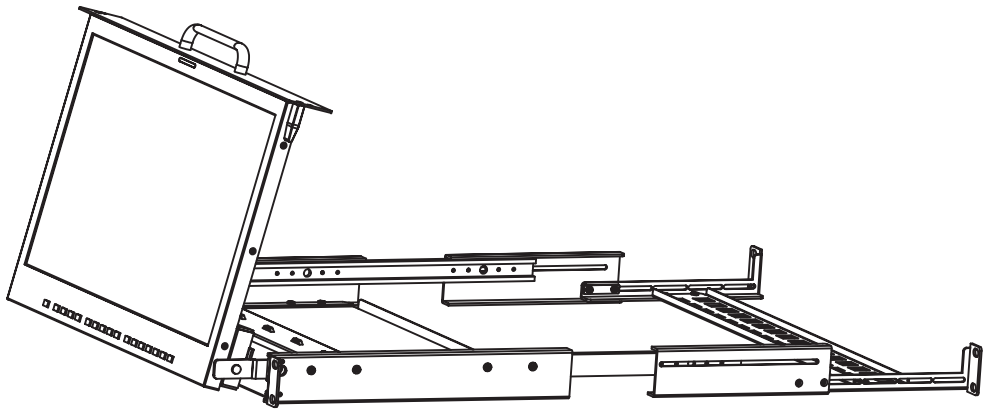

Konvision Monitor
KFM-5X / 6X series LCD Monitors

USER MANUAL

About This Manual

The instructions in this manual are for KFM-5X/6X series LCD Monitors .
The following description uses model KFM-1753W&KFM-1760D pictures.
Please confirm the model number of the device before reading this manual.

Catalogue

Notes..... 2

Notes 2

Security 2

- Screen Maintenance 2
- Cabinet Maintenance 2
- Installation 3
- Rack mount Installation 3
- Transportation 3
- The following does not belong to failures:..... 3

Features..... 3

- High Brightness LCD Panel..... 3
- High Brightness Tally Indicator ... 3
- Auto-detection of all color system (PAL, NTSC)..... 3
- 3D Video Decoder 3
- Motion-Adaptive Interlace to 3
- Progressive 3
- 10BIT Signal Processing 4
- Support Multiformat SDI Signals 4
- Y/C Input 4
- SDI Input 4
- YPbPr Input..... 4
- HDMI/DVI/VGA Input..... 4
- Signal Source Loop Through..... 4
- PIP/PBP 4
- SWAP Function 4
- Color Temperature..... 4
- Image Size Setting 4
- Marker Setting 4
- HV Delay 4
- Color Space 4
- Color Calibration..... 4
- Scan Mode 5
- Part Zoom In..... 5
- Audio level meter (UV+PPM) 5
- Waveform 5
- Focus Assist 5
- False Color 5

- Histogram 5
- Vector scope..... 5
- Over exposure..... 5
- Pixel Measurement..... 5
- Timecode..... 5
- Remote Control Function 5

Parts and Functions 6

- Front View 6
- Rear View 8
 - KFM-1753W rear view port:8
 - KFM-1760D rear view port:8

OSD Menu 9

- Menu Operation..... 9
- Menu Item Description 9
 - Main Menu:9
 - Sub Menu:.....10
 - Status:10
 - Function Key:10
 - Picture:11
 - Image:11
 - Audio:12
 - Marker:13
 - Scope:14
 - Embedded code:15
 - Layout:15
 - IMD:.....17
 - Alarm:18
 - Setup:18
 - Key Lock:19
 - 3. Function Key.....19

Function Key Menu Operation

Instructions 19

Dual picture operation 20

Pixel Measurements Operating

Instructions 20

SDI 2K Signal Display Description20

Factory Reset..... 20

Remote Control..... 21

Rack quick installation process... 21

Note..... 23

Notes

Notes

For the safety use of products, please read the following instructions regarding the installation, use and maintenance carefully.

- Please read the product safety and operating instructions carefully before the product is operated.
- Please keep the safety and operating instructions for future reference.
- Please pay strict attention to the warnings and implement the products according to the operating instructions closely.
- All operating instructions should be strictly enforced.

1. Please use the power cord recommended by the manufacturer.
2. Please do not place heavy objects on the power cord.
3. Please do not expose the monitors to rain, humid, dusty places.
4. Please do not place vessels with liquid (such as cups, beverage bottles) on the monitor.
5. Please do not place this product in high heat places.
6. Please make sure the earth terminal is good in order to avoid electric shock.
7. Please do not open the back cover to avoid electric shock. Please contact professionals for service needs.
8. If there is no image or sound, please unplug the power cord from the AC outlet immediately. Please consult professionals if problem still exists after examining carefully.
9. Do not place this product at unstable places such as cars, shelves or tables, as it is easy to make the product fall down, may cause severe hurt to children and adults and damage to the product.
10. Please do not touch the power plug with wet hands, as it will cause electric shock.
11. Please do not expose the LCD panel in direct sunlight for a long time, it will result in damage or aging of the LCD panel.
12. Please display this product at a suitable temperature and humidity.
13. Please do not spray any liquid things and/or add any objects into the monitor, it might cause voltage instability and short-circuit, also can easily cause fires and blackouts.

14. If do not use the device for a long time, please unplug the power cord from the AC outlet.
15. Please keep not less than 5cm space around the vents while using the monitor, in order to obtain a good heat dissipation effect.

Security

Screen Maintenance

Please follow the below guidelines carefully to prevent discoloration, stains and scratches on the screen:

- Avoid striking the screen with any object.
- Do not wipe the screen hard.
- Do not wipe the screen with solvents such as alcohol, thinner or gasoline.
- Do not spray detergent or other cleaners on the monitor or LCD panel, as it may cause fault because of water droplets into the monitor.
- Do not write on the screen.
- Do not paste or stick any viscous markers on the screen.

Screen may be cleaned by gently wiping with lint free cloth to remove dust. For the more difficult cleaning, use lint free cloth that has been very lightly dampened with detergent, then dry any excess moisture from the monitor or LCD panel immediately to prevent damage.

Cabinet Maintenance

Please follow the guidelines below to prevent potential damage.

- Do not wipe the cabinet with solvents such as alcohol, thinner or gasoline.
- Do not use any pesticides and/or other volatile substances.
- Do not allow prolonged contact with rubber or plastic.
- Do not wipe the cabinet hard. Use a soft, lint free cloth to clean. If the cabinet cleaning is more difficult, use lint free cloth that has been very lightly dampened with detergent and then dry it to wipe.

Installation

- Keep adequate air circulation to prevent device internal overheating. Please do not place the product on the surface of some certain objects (such as blankets, carpets, etc.), as these objects may block the vents.
- Please keep the device away from heat generating sources, such as radiator, heaters and air duct, also keep it away from much dust or mechanical vibration.

Rack mount Installation

For rack mount installation, please keep 1U space from both top and bottom to make sure, adequate air circulation, or install an external electric fan. Please follow the instructions and install with the rack mounts provided by the manufacturer.

Transportation

This monitor is precise equipment and needs professional packing materials to transport. Please do not use packing materials provided by suppliers except KONVISION or its authorized packing material suppliers.

When the following situations occur, please turn off the power, do not insert the plug and contact a professional service staff to deal with it in a timely manner.

1. This product smells of smoke and off-flavor.
2. When this product displays abnormal operating conditions, such as there is no picture or sound.
3. When any liquid is splashed into the product or product dropped.
4. When the product soaked or fell into the water.
5. When the product has been damaged or under other easy to get damaged circumstances.
6. When the power cord or plug is damaged.

The following does not belong to failures:

1. If the static image displayed too long, it will have residual image, which should be attributed to the characteristics of LCD display but not a failure. Residual image will disappear automatically after a period of time.

2. If this device is used in a cold environment, the screen may appear a burn-in image. This is not a product failure, when the monitor temperature changes, screen will return to normal conditions.
3. LCD screen may appear tiny spots (red, blue or green), this is not a fault, LCD screens are manufactured with high precision technology, and a small number of pixels may not be able to show intermittent.
4. Screen and cabinet will become warm gradually during operating.

Features

High Brightness LCD Panel

- High brightness, high contrast, high-speed response and wide viewing angle technology makes the monitor can be used under variety of lighting conditions.

High Brightness Tally Indicator

- The tally function via GPI or LAN port, with two colors red and green.

Auto-detection of all color system (PAL, NTSC)

- This unit detects the color system automatically.

3D Video Decoder

- Process 3D decoding on VIDEO signals, to realize better reduce cross color.

Motion-Adaptive Interlace to Progressive

- It converts interlaced video to progressive video by motion detection, reduce the serrated image.

10BIT Signal Processing

- Signal input, signal processing and image output are 10bit data processing, to ensure the details display of the image.

Support Multiformat SDI Signals

- The SDI interface supports SD-SDI, HD-SDI, dual link HD-SDI and 3G SDI inputs.

Y/C Input

- Decomposition for the luminance signal (Y) and chrominance signals (C) of the video signal can be input through this connector.

SDI Input

- Support multi-format SDI input, SD-SDI, HD-SDI, 3G SDI.
- Support SMPTE425M-A/B 4:4:4 signals.

YPbPr Input

- YPbPr video signal (Compatible YCbCr) can be input through this connector.

HDMI/DVI/VGA Input

- HDMI signal can be input via HDMI to DVI-I converter through DVI connector, DVI signal can be input through DVI connector, VGA signal can be input via VGA to DVI-I converter through DVI connector.

Signal Source Loop Through

- Signal that linked to the input connector will be enlarged and linked to output connector. SDI reclock loop out ensure the signal without enervation.

PIP/PBP

- Two SDI inputs signals display simultaneously under PIP (picture in picture) and PBP (picture by picture) mode. One SDI input signal can be also displayed with another signal of VIDEO, S-VIDEO, COMPONENT, HDMI simultaneously, and showing two pictures on the screen.

SWAP Function

- In PIP/PBP mode, two pictures can be swapped between each other.

Color Temperature

- Different color temperatures can be selected freely.

Image Size Setting

- The display mode is switchable among 16:9, 4:3, full screen, 1:1, and the original image proportion.

Marker Setting

- Show frame borders, center marker, and safety area, etc.

HV Delay

- Display horizontal and vertical blanking area of SDI input signal.

Color Space

- Color space include: Rec 709, EBU, DCI P3 D65, DCI P3, Rec2020, USER. (This function only available to KVM-6X series)

Color Calibration

- This enable to calibrate imported color data of the image being measured by color analyzer. (This function only available to KVM-6X series, specific instructions please contact with the dealer.)

Scan Mode

- Scan mode includes Full Scan, Over Scan, Under Scan. Full scan displays the content of all areas of the input signal. Over scan displays 105% of the area of the input signal. Under scan displays 95% of the area of the input signal.

Part Zoom In

- Zoom in any part of the picture, to watch picture details more clearly, and assist for focus.

Audio level meter (UV+PPM)

- Display the audio level meter (UV+PPM) for SDI embedded audio.

Waveform

- Display input signal waveform and color scope for SDI signal input monitoring. It includes luminance waveform, CbCr waveform. Luminance waveform will mark with red if over the value specified by user.

Focus Assist

- Focus assist is to aid the cameraman focus on the main body by marking the sharpest edge of the image with red.

False Color

- False color can intuitively observe and calculate illumination level in the image, luminance and illumination values display mapping as luminance level, from darkest to brightest, display blue, cyan, green, yellow, orange and red in turn.

Histogram

- YRGB histogram displays the hue distribution of the entire image under SDI input condition, can intuitively display exposure of the image, display R, G, B 3 channels independently.

Vector scope

- Vector UV analysis for color bar signal input.

Over exposure

- Over exposure is to aid the cameraman accurately control the lighting to avoid over exposure by marking the brightness exceeds the user-specified range (95% by default) with the form of covering zebra pattern.

Pixel Measurement

- User can measure any pixel's specific position and RGB value, also can compare the YRGB value between any 2 pixels.

Timecode

- Display SMPTE timecode (LTC, VITC1, VITC2) under SDI input, it is used for identifying and synchronizing of video data streams.

Remote Control Function

- Available to connect to the remote terminal to operate the equipment directly, select the input signal, longitudinal mode settings and tally indicator, etc.

Parts and Functions

Front View

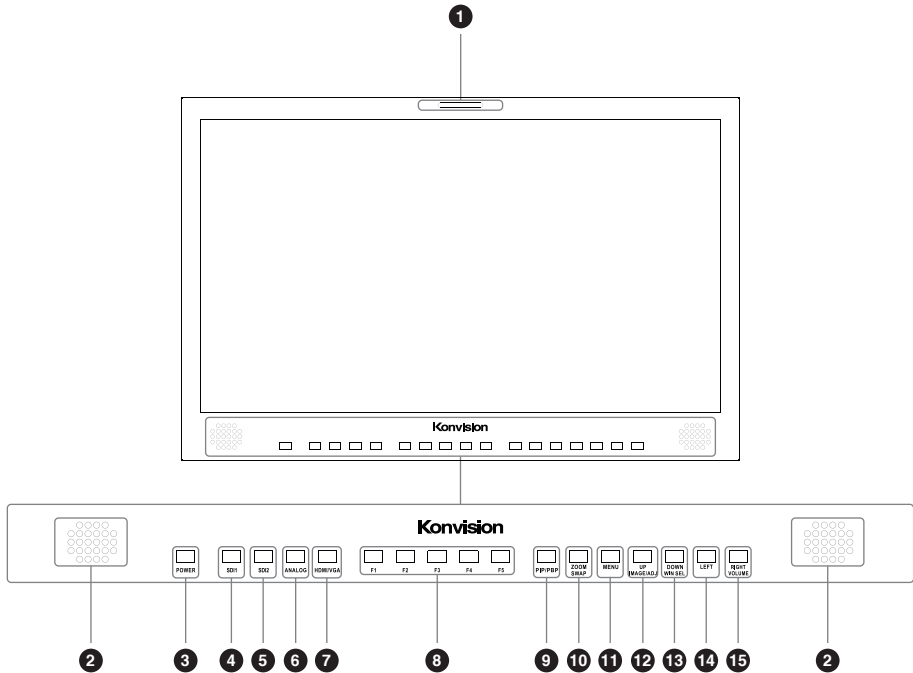

1 Tally Indicator

Control method of Tally light.

1. GPI port(control method: please look the GPI port description).
2. RS422 Port: support use TSL3.1 or TSL 4.0 protocol control the tally light.

2 Speaker

Stereo audio output.

3 Power Button and Indicator

When the external AC power supply with electricity, the indicator light is red. Press this POWER button to power on the monitor, and the indicator light turns blue. Press this button for about 2 seconds, can turn off the monitor, the indicator light turn red.

4 SDI1 Button and Indicator

Press this button to select SDI1 signal input, indicator turns blue.

5 SDI2 Button and Indicator

Press this button to select SDI2 signal input, indicator turns blue.

6 ANALOG Button and Indicator Light

Press this button to select input signal between YPbPr, Video, S-video, indicator turns blue.

7 HDMI/VGA Button and Indicator Light

Press this button to select signal input among DVI/ HDMI/VGA, indicator turns blue.

8 F1-F5 Button and Indicator Light

F1-F5 these buttons can be used as shortcut buttons. Press the F1-F5 buttons to select the corresponding function.

When the set button function item is set to off in the main menu, those buttons are invalid.
F1-F5 These button functions can be set in the menu Function key options.

9 PIP/PBP Button

Press this button for window layout among single, PIP, PBP mode. In PIP/PBP mode, one of the signals must be SDI1 input, the other can be any of SDI2, HDMI, PC, Video, YPbPr, etc.

10 ZOOM/WIN SEL Button

At single mode: press this button to zoom in
At PIP/PBP mode: press this button to swap 2 windows rapidly.

11 MENU Button

Press this button to display the OSD menu, and press it again to exit the menu.
Clear the Marker display.
Clear Display mode.
Turn off the shortcut menu.

12 UP/IMAGE ADJ Button

When in OSD main menu, press this button to select up sub-menus.
When not in OSD menu, press this button to show backlight, brightness, and contrast respectively.
The display has the following changes:

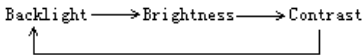

Backlight: The screen backlight brightness adjustment shortcut menu display, press the LEFT button or (RIGHT / VOLUME) button to adjust the brightness of the screen backlight.

Brightness: The image brightness adjustment shortcut menu is displayed. Press the LEFT button or the (RIGHT / VOLUME) button again to adjust the image brightness.

Contrast: The image contrast adjustment shortcut menu is displayed. Press the LEFT button or the (RIGHT / VOLUME) button again to adjust the image contrast.

13 DOWN/WIN SEL Button

When entering the menu operation, press to select the menu item.
When the screen is in the PIP / PBP state, press this button to select one of the picture. In this case, you can press other buttons to set the parameters of the selected screen independently, without affecting the parameters of the other screen.

14 LEFT Button

When entering the menu operation, press this button to select the menu item.
When not in the menu operation, press this button to enter the volume adjustment shortcut menu.
When entering the shortcut menu, press this key to adjust the scroll bar to the left.

15 RIGHT/VOLUME Button

When entering the main menu operation, press this button to select the sub menu to the right.
When entering the sub menu operation, press this button to adjust the parameters of the current sub menu item to the right.
When not in the menu operation, press this button to enter the volume adjustment shortcut menu.
When entering the shortcut menu, press this button to adjust the scroll bar to the right.

Rear View

KFM-1753W rear view port:

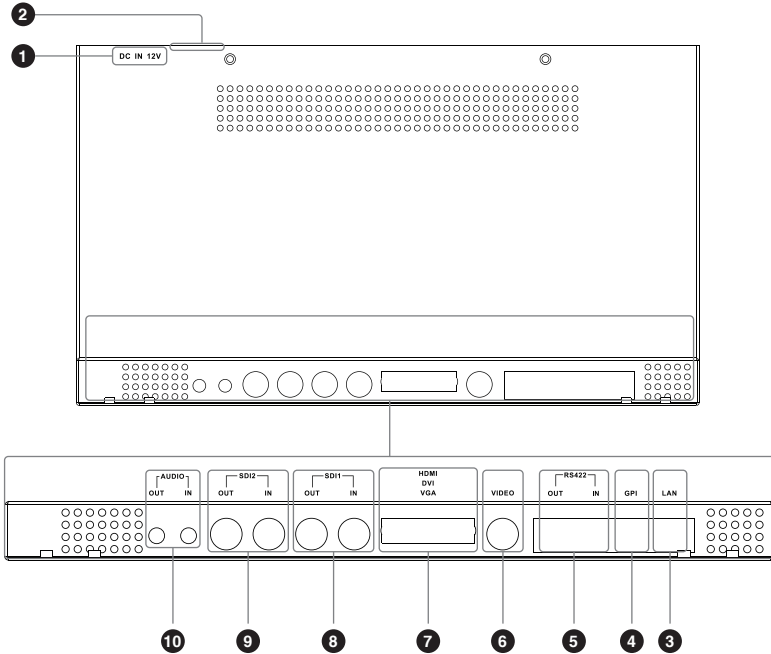

KFM-1760D rear view port:

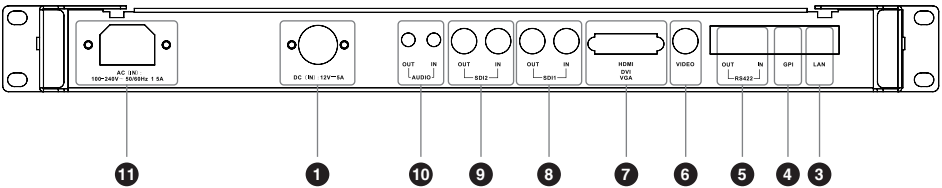

1 DC 12V IN

12V DC power supply.

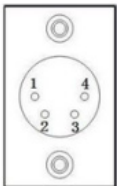

Pin 1: GND
 Pin 2: NC (No connect)
 Pin 3: NC (No connect)
 Pin 4: 12V

The interface pins are defined as:

- Pin 1: Ground
- Pin 2: NC
- Pin 3: NC
- Pin 4: +12V

2 ON/OFF
 Power button.

3 LAN

In shortcut functions: Turn the knob to adjust the value of Brightness, Contrast and Chroma respectively. Ethernet port for remote network control. Thought this port, along with software "Konvision Device Controller", you can achieve remote controlling to the monitor easily. (remote control software & instructions please contact with the dealer)

4 GPI

GPI interface:

Diagram	Pin	GPI Signal	Description
	1	GPI1	when connect GND, GPI1 works, GPI1 function can be set in the menu function option.
	2	GPI2	when connect GND, GPI2 works, GPI2 function can be set in the menu function option.
	3	GPI3	when connect GND, GPI3 works, GPI3 function can be set in the menu function option.
	4	TX	RS232-TX, for MCU program upgrade, please contact the dealer for upgrade operation. When the program is not upgraded, the suspension is not connected.
	5	RX	RS232-RX, for MCU program upgrade, please contact the dealer for upgrade operation. When the program is not upgraded, the suspension is not connected.
	6	GPI4	when connect GND, GPI4 works, GPI4 function can be set in the menu function option.
	7	NC	Not connect
	8	GND	Ground

5 RS422 IN and RS422 OUT

RS422 input and output interfaces. RS422 use TSL3.1 or TSL4.0 protocol to control. According to the protocol, it can realize UMD and Tally control.

Diagram	Pin	RS422 IN Signal name	RS422 OUT Signal name
	1	GND	GND
	2	GND	GND
	3	Tx-	Tx-
	4	Rx+	Rx+
	5	Rx-	Rx-
	6	Tx+	Tx+
	7	NC	NC
	8	NC	NC

6 VIDEO

Video signals input.

7 HDMI/DVI/VGA

DVI input, support DVI signal, HDMI signal (via HDMI-DVI converter), and VGA signal (via VGA-DVI converter)

8 SDI IN/OUT

SDI1 inputs (3G/HD/SD-SDI auto detect), SDI Reclock loop through output, without enervation.

9 SDI2 IN/OUT

SDI2 inputs (3G/HD/SD-SDI auto detect), SDI Reclock loop through output, without enervation.

10 AUDIO(IN/OUT)

Audio in used for analog signal input, Audio out used for monitoring with 3.5mm earphone.

11 AC Faucet

Using for AC power connect.

OSD Menu

Menu Operation

1. MENU Button:

Press the Menu button, the main menu will be displayed on the screen, and press the MENU button again to exit the menu.

When in sub-menu, press the MENU button to return to previous menu.

When in setting option, press the MENU button to return to exit.

2. IMAGEADJ(UP/DOWN) Knob:

When in the main menu or sub menu, the menu item can be selected by pressing the UP / DOWN button to select up / down functions.

3. VOLUME(LEFT/RIGHT) Knob:

When in the main menu, enter the sub menu by pressing RIGHT button.

When in the sub menu, the parameters can be adjusted by pressing the LEFT / RIGHT function button.

Menu Item Description

1. Main Menu:

Main menu	Menu item
Status	1
Function Key	1
Picture	1
Image	1
Audio	1
Marker	1
Scope	1
Embedded code	1
Layout	1
IMD	1
Alarm	1
Setup	1
Key Lock	1

2. Sub Menu:

Status:

Main Menu	Status	
Status	Source&Format	SD11 1920x1080i50
Function Key	Fh	28121Hz
Picture	Fv	50Hz
Image	Color Temp	6500
Audio	Color Space	Rec 709
Marker	Image Size	FILL ASPECT
Scope	Scan Mode	100% Scan
Embedded code	Screen Saver	YES
Layout	Power Saving	YES
IMD	MCU Firmwave Version	XSDIIM A Jun 10 2017
Alara	DSP Firmwave Version	7-0-19-2
Setup		
Key Lock		

Sub Menu	Description
Source & Format	Current window input signal and resolution.
Fh	The line frequency of the current window input signal.
Fv	The field frequency of the current window input signal.
Color Temp	The current color temperature.
Color Space	The current color space.
Image Size	The image size of the current window input signal.
Scan Mode	The signal scan mode of the current window input signal.
Screen Saver	System screen saver status.
Power Saving	System power saving mode status.
MCU Firmwave Version	CPU software version
DSP Firmwave Version	DSP software version

Function Key:

Main Menu	Function Key	
Status	F1	Image Size
Function Key	F2	Marker Enable
Picture	F3	Audio Level Meter
Image	F4	TimeCode Display
Audio	F5	Waveform Mode
Marker	GPI1	Blue Mode
Scope	GPI2	Red TALLY
Embedded code	GPI3	Green TALLY
Layout	GPI4	Marker Enable
IMD		
Alara		
Setup		
Key Lock		

Sub Menu	Description
F1	The Function keys can be set to the following functions: Image Size, No Definition, static frame, Time Code Display, Audio Level Meter, Audio Phase, Waveform Mode, Vector, Focus Assist, Pixel Measurement, False Color, Zebra, Histogram, Picture Flip, Fast Mode, Blue Mode, Gray Mode, Marker Setting. (Note: Black stretch: When the function key is set to black stretch, press the function key to increase the brightness of the low-brightness part of the screen.)
F2	Same as above
F3	Same as above
F4	Same as above
F5	Same as above
GPI1	Can be set to the following functions: Blue Mode, Image Size, Marker Display, No Definition, Red TALLY, Green TALLY, SDI1, SDI2, HDMI, DVI, VGA, YPbPr, Video, S-Video.
GPI2	Same as above
GPI3	Same as above
GPI4	Same as above

Picture:

Main Menu	Picture	
Status	Backlight	013
Function Key	Data Levels	Limit (64-940)
Picture	Brightness	050
Image	Contrast	059
Audio	Sharpness	007
Marker	Colour	050
Scope	Hue	050
Embedded code	Colour Temp	6500K
Layout		
IMD		
Alara		
Setup		
Key Lock		

Sub Menu	Description
Backlight	Backlight Adjustment. · 0-100
Data Levels	[Limit (64-940)] Select Limit (64-940), video level. [Extend (64-1023)] Select Extend (64-1023), ultra-white. [Full (0-1023)] Select Full (0-1023), full data level. [Custom] Custom is for user definition. · Limit (64-940) · Extend (64-1023) · Full (0-1023) · Custom
Brightness	Brightness Adjustment. · 0-100
Contrast	Contrast Adjustment. · 0-100
Sharpness	Sharpness Adjustment. · 0-15
Colour	Saturation Adjustment. · 0-100
Hue	Color Adjustment.. · 0-100

Sub Menu	Description
Colour Temp	Three modes of the fixed color . temperatures selection (5600K, 6500K, 9300K) and a custom selection. "Custom" is for user definition, to adjust the gain value and offset value of Red, Green and Blue. It will save the color temperature setting automatically. · 5600K · 6500K · 9300K Custom: Red Gain 0-255 Green Gain 0-255 Blue Gain 0-255 Red offset 0-255 Green offset 0-255 Blue offset 0-255

Image:

Main Menu	Image	
Status	Image Size	FILL ASPECT
Function Key	Scan Mode	100%Scan
Picture	Part Zoom In	<Right>Enter, <ZOOM>Part Zoom In
Image	Gray Mode	OFF
Audio	Blue Mode	OFF
Marker	Fast Mode	OFF
Scope	H/V Delay	OFF
Embedded code	Log Mode	OFF
Layout	ColorSpace	Rec 709(Gamma2.4)
IMD	Start Color Correction	<Right>to start color Correction
Alara		
Setup		
Key Lock		

Sub Menu	Description
Image Size	[FILL ASPECT] Original ratio of the signal source. [Full Screen] Full screen image. [1: 1] At 1:1 pixel-to-pixel display. It is invalid in PIP sub-screen and PBP mode. [16: 9] 16:9 aspect ratio. [4: 3] 4:3 aspect ratio. · FILL ASPECT · Full Screen · 1: 1 · 16: 9 · 4: 3
Scan Mode	[100% Scan] 100% Image display. [Over Scan 5%] 105% Image display. [Under Scan 5%] 95% image display. · 100% Scan · Over Scan 5% · Under Scan 5%

Sub Menu	Description
Part Zoom in	Zoom in any part of the picture, to watch picture details more clearly, and assist for focus. · <Right>Enter, <PIP>Part Zoom in
Gray Mode	Monochrome mode with black and white image. · On · Off
Blue Mode	Display in Blue only. · On · Off
Fast Mode	Interlace scan without converting into progressive scan. · On · Off
H/V Delay	Display horizontal & vertical blanking area of SDI input signal. · On · Off
Gamma Mode	Users can choose different Gamma or turn it off (this function only available to KVM-6X series) · Turn off · Gamma 2.0 · Gamma 2.2 · Gamma 2.4 · Gamma 2.6 · Rec.2100 HLG 1.0 · Rec.2100 HLG 1.1 · Rec.2100 HLG 1.2 · Rec.2100 HLG 1.3 · Rec.2100 HLG 1.4 · Rec.2100 HLG 1.5 · ST2084 PQ · S-Log3 (HDR) · Slog (SDR) · Slog2 (SDR) · Slog3 (SDR)

Sub Menu	Description
Color Space	[Bypass] Color Space Choose Bypass. [Rec 709] Color Space Choose Rec709. [EBU] Color Space Choose EBU. [DCI P3 D65] Color Space Choose DCI P3 D65. [DCI P3] Color Space Choose DCI P3. [Rec2020] Color Space Choose Rec2020. [USER1] Color Space Choose User1. [USER2] Color Space Choose User2. · Bypass · Rec 709 · EBU · DCI P3 D65 · DCI P3 · Rec2020 · USER1 · USER2 Remark: 1. KVM-5X series only support Rec709 and Bypass. 2. User1 and user2 option, support user loads their own LUT table, store in there, specific instructions please contactwith the dealer.
Start Color Correction	In the menu of Color calibration, press right key to start color calibration, must connect with color analyzer to start color calibration. Notice: restart the monitor to back from color calibration function when misled to the function. · <Right> to start color Correction

Audio:

Main Menu	Picture	
Status	Backlight	013
Function Key	Data Levels	Limit (64-940)
Picture	Brightness	050
Image	Contrast	059
Audio	Sharpness	007
Marker	Colour	050
Scope	Hue	050
Embedded code	Colour Temp	6500K
Layout		
IMD		
Alara		
Setup		
Key Lock		

Sub Menu	Description
Volume	Speaker volume adjustment. · 0-100

Sub Menu	Description
Headphone Volume	Headphone volume adjustment. · 0-100
Audio Out Mode	[Normal] Right Channel MuteLeft and right channel out normal. [Left Channel Mute] Left channel mute, just out the right channel. [Right Channel Mute] Right channel mute, just out the left channel. · Normal · Left Channel Mute · Right Channel Mute Remark: Only for SDI and HDMI/DVI signal.
Audio Out Channel	When in SDI Signal: SDI embedded audio select in CH1&CH2, CH3&CH4, CH5&CH6, CH7&CH8. When in HDMI Signal: HDMI embedded audio selects in CH1&CH2. · CH1&CH2 · CH3&CH4 · CH5&CH6 · CH7&CH8 Remark: Only for SDI and HDMI/DVI signal.
Headphone Volume	Turn on/off audio level meter display. · On · Off Remark: Only for SDI and HDMI/DVI signal.
Audio Display Channels	When in SDI Signal: 1-4 channels: 1-4 channels are displayed horizontally or vertically on the left side of the screen. 1-8 channels: 1-8 channels are displayed horizontally or vertically on the left side of the screen. 1-16 channels: 1-8 channels are displayed horizontally or vertically on the left side of the screen. 9-16 channels are displayed horizontally or vertically on the left side of the screen. When in HDMI Signal: Only displayed 1-2 channel horizontally or vertically on the left side of the screen.1-4 Channel · 1-8 Channel · 1-16 Channel · 9-16 Channel · 1-2 Channel Remark: Only for SDI and HDMI/DVI signal.

Sub Menu	Description
Audio Display Mode	[Horizontal] Audio level meter display. [Vertical] horizontal/vertical. · Horizontal · Vertical Remark: Only for SDI/HDMI/DVI signal.
Audio Phase Meter	Turn on/off Audio Phase Meter display. · ON · OFF Remark: Only for SDI/HDMI/DVI signal.
Audio Phase Channel	When in SDI Signal: SDI Audio Phase Channel can be selected in CH1&CH2, CH3&CH4, CH5&CH6, CH7&CH8. When in HDMI Signal: HDMI Audio Phase Channel only can be selected in CH1&CH2. · CH1&CH2 · CH3&CH4 · CH5&CH6 · CH7&CH8 Remark: only for SDI and HDMI/DVI signal.
Audio Phase Channel	Turn on/off audio level meter display. · On · Off Remark: only for SDI and HDMI/DVI signal.

Marker:

Main Menu	Marker Setting	
Status	Marker Enable	OFF
Function Key	Marker Select	4:3
Picture	Target Marker	Center
Image	Safety Area	OFF
Audio	Marker Level	Middle
Marker	Marker Mat	Translucency
Scope		
Embedded code		
Layout		
IMD		
Alarm		
Setup		
Key Lock		

Sub Menu	Description
Marker Enable	[ON] All markers on. [OFF] All markers off. · ON · OFF
Marker Select	[OFF] NO marker displays. [4:3] Marker display 4:3. [16:9] Marker display 16:9. [15:9] Marker display 15:9. [14:9] Marker display 14:9. [13:9] Marker display 13:9. [1.85:1] Marker display 1.85:1. [2.35:1] Marker display 2.35:1. · OFF · 4:3 · 16:9 · 15:9 · 14:9 · 13:9 · 1.85:1 · 2.35:1
Target Marker	[ON] Turn on target marker. [OFF] Turn on center mark. [USER] Turn on user target tag. · ON · OFF · USER
Safety Area	[OFF] No Safety Area display. [80%] 80% Safety Area display. [85%] 85% Safety Area display. [88%] 88% Safety Area display. [90%] 90% Safety Area display. [93%] 93% Safety Area display. · OFF · 80% · 85% · 88% · 90% · 93%
Marker Level	[White] Maker line is white. [Gray] Marker line is gray. [Black] Marker line is black. · White · Gray · Black
Target Marker	[OFF] Turn off Fill up the background beyond marker. [Gray] Background beyond marker is gray. [Black] Background beyond marker is black. [Half Transparency] Background beyond marker is half transparent . · OFF · Gray · Black · Half Transparency

Scope:

Main Menu	Scope	
Status	Waveform Mode	OFF
Function Key	Waveform Alarm	100%
Picture	Waveform Scale	Digital
Image	Histogram Mode	OFF
Audio	Vector	OFF
Marker	Vector Scale	100%
Scope	Zebra	OFF
Embedded code	Zebra Level	95%
Layout	Pixel Measure	OFF
IMD	False Color	OFF
Alarm	focus Assist	OFF
Setup	Focus Gain	25
Key Lock	Focus Color	RED
	H Flip	OFF

Sub Menu	Description
Waveform Mode	[OFF] Turn off the waveform mode. [LUMA] Display Y(luminance) waveform. [YUV] Display YCbCr waveform. [FULL LUMA] Display Y (luminance) waveform, one-to-one correspondence between its horizontal coordinates and image horizontal coordinates. · OFF · LUMA · YUV · FULL LUMA
Waveform Alarm	Waveform alarm can be set at any percentage between 84%-100%, it will alarm when measured waveform reach or exceed the value you set and mark them with red. · 84%-100%
Waveform Scale	[Digital] Display in digital. [IRE] Display in percentage of luminance. · Digital · IRE
Histogram Mode	[OFF] Turn off the histogram mode. [LUMA] Display luminance histogram. [RGB] Display R G B histogram. · OFF · LUMA · RGB
Vector	Turn on/off vector. · ON · OFF

Sub Menu	Description
Vector Scale	[100%] Vector 100% display. [75%] Vector zoom out to 75% display. · 100% · 75%
Zebra	Turn on/off zebra. · ON · OFF
Zebra Level	Zebra level can be set at any percentage between 84%-100%, it will alarm when measured luminance reach or exceed the value you set and overlay display with red zebra stripes. · 84%-100%
Pixel Measure	Turn on/off pixel measure. · ON · OFF
False Color	Turn on/off false color. · ON · OFF
Focus Assist	Turn on/off focus assist. · ON · OFF
Focus Gain	Focus gainadjustment0-31. · 0-31
Focus Color	[Red] Focus color use Red. [Green] Focus color use Green. [Blue] Focus color use Blue. [White] Focus color use White. · Red · Green · Blue · White
H Flip	Turn on/off Horizontal flip. · ON · OFF

Embedded code: (Only for SDI signal)

Main Menu	Embedded code	
Status	TimeCode Display	OFF
Function Key	TimeCode Mode	LTC
Picture		
Image		
Audio		
Marker		
Scope		
Embedded code		
Layout		
IMD		
Alarm		
Setup		
Key Lock		

Sub Menu	Description
Time Code Display	Turn on/off Time code. · ON · OFF
Time Code Mode	[LTC] Time code display as LTC mode. [VITC1] Time code display as VITC1. [VITC2] Time code display as VITC2. · LTC · VITC1 · VITC2

Layout:

Main Menu	Layout	
Status	Layout	Single
Function Key	Main Window Source	SDI1
Picture	Current Source Rename	SDI1
Image		
Audio		
Marker		
Scope		
Embedded code		
Layout		
IMD		
Alarm		
Setup		
Key Lock		

Sub Menu	Description
Layout	<p>[Single]Display only a single signal picture on screen. [PIP]Display two signals pictures simultaneously on screen, the sub picture in the main picture. [Side by Side]Display two signals pictures side-by-side simultaneously on screen, the sub picture at the right side of the main picture.</p> <ul style="list-style-type: none"> · Single · PIP · Side by Side <p>Remark: In PIP/PBP mode, one of the signals must be SD11, the other signal is any of other input signals. Can display 2 SDI simultaneously.</p>
Main Window Source	<p>Main Window select signal input among Video/ S-Video/ YPbPr/ SDI1/SDI2/VGA/ HDMI</p> <ul style="list-style-type: none"> · Video · S-Video · YPbPr · SDI1 · SDI2 · VGA · HDMI · DVI <p>Remark: YPbPr is compatible with RGB, YCbCr, YPbPr.</p>
Second Window Source	<p>Second Window select signal input among Video/ S-Video/ YPbPr/ SDI1/SDI2/VGA/ HDMI</p> <ul style="list-style-type: none"> · Video · S-Video · YPbPr · SDI1 · SDI2 · VGA · HDMI · DVI <p>Remark: 1.YPbPr is compatible with RGB, YCbCr, YPbPr. 2.This item shows in PIP/PBP.</p>
PIP Size	<p>[Large]The second window is Large size. [Middle]The second window is medium size. [Small]The second window is small size.</p> <ul style="list-style-type: none"> · Large · Middle · Small <p>Remark: 1.This item shows in PIP.</p>

Sub Menu	Description
PIP position	<p>[Left Top]The second window in the left-top corner of screen. [Right Top]The second window in the right-top corner. [Center]The second window in the center. [Right Bottom]The second window in the right-bottom corner. [Left Bottom]The second window in the left-bottom corner. [Custom]The second window is adjusted by user.When the user selects this option, it will automatically pop up at the following "horizontal position" and "vertical position" menu items.</p> <ul style="list-style-type: none"> · Left Top · Right Top · Center · Right Bottom · Left Bottom · Custom
H Position	<p>Horizontal position adjustment of picture-in-picture's second window.</p> <ul style="list-style-type: none"> · 0-100 <p>Remark: This item shows when PIP position selects "Custom"</p>
V Position	<p>Vertical position adjustment of picture-in-picture's second window.</p> <ul style="list-style-type: none"> · 0-100 <p>Remark: This item shows when PIP position selects "Custom"</p>
Alpha Blend	<p>Adjustment of PIP's second window and the main window alpha blend degrees. When the value is 0, the second window is translucent blend with the main window; when the value is 100, the second window blend directly to the main screen.</p> <ul style="list-style-type: none"> · 0-100
Swap	<p>In PIP and PBP, turn right the VOLUME knob to swap the signal pictures between two windows (main window and second window).</p> <ul style="list-style-type: none"> · <Right> to swap two windows <p>Remark: This item shows in PIP/PBP mode.</p>

Sub Menu	Description
Current Source Rename	The current signal rename display characters can be arbitrarily set in 8 "xxxxxxx". The setting process: Select the option to the character option, press the VOLUME (LEFT / RIGHT) knob, the option is displayed as "xxxxxxx ok", and the first character becomes red, the user can rotate VOLUME (LEFT / RIGHT) Button to select the desired character. After the first bit is finished, press the VOLUME (LEFT / RIGHT) knob, the second character will be skipped, the second character will be red, and the VOLUME (LEFT / RIGHT) Select the desired character, and so on, the eighth character selection, when the eighth character selection is good, press the VOLUME (LEFT / RIGHT) knob, then "ok" will turn red, rotate VOLUME (LEFT / RIGHT) Knob to "ok" will turn yellow, then press the MENU button to save the exit can be completed UMD main screen character settings. In the setting, only the character "ok" for the yellow state press the MENU button to exit will make the previous character settings saved successfully. If you do not change the "ok" character from red to yellow and press MENU to exit, the previously set characters are not saved.

IMD:

Main Menu	IMD	
Status	UMD Display	OFF
Function Key	UMD ID	128
Picture	UMD Position	Bottom Center
Image	UMD Local Color	GREEN
Audio	UMD Main Window Char	UMD-WIN0
Marker	UMD Second Window Char	UMD-WIN1
Scope	UMD PROTOCOL	TSL 3.1
Embedded code	OSD Tally Mode	RG
Layout	LED Tally	OFF
IMD	LED Tally Source	CPI
Alarm		
Setup		
Key Lock		

Sub Menu	Description
UMD Display	Turn on/off the UMD display. · ON · OFF
UMD ID	UMD ID can be set any value from 128-255. It can be used for multidevice cascading, set different UMD ID for different devices. In remote control situation, this function can be used for distinguishing different devices so as to remote control different devices. · 128-255
UMD Position	[Top Left] UMD display at Top Left. [Top Center] UMD display at Top Center. [Bottom Center] UMD display at Bottom Center. [Bottom Right] UMD display at Bottom Right. · Top Left · Top Center · Bottom Center · Bottom Right
UMD Local Color	[GREEN] UMD character display in green. [RED] UMD character display in red. [White] UMD character display in white. · GREEN · RED · White
UMD Main Window Char	It can be set any character in "xxxxxxx". Setup process: Select the UMD Main Window item, press VOLUME knob, it shows "xxxxxxx ok", meanwhile, the first character becomes red, user can select the character you need by rotating the VOLUME knob (Left/Right), press the VOLUME knob after finishing first character, it will turn to the second character, select the character you need same as first character, it's also applied to other characters. After finishing selecting the 8th character, press the VOLUME knob, the "ok" will turn red, rotate the VOLUME knob to make the "ok" turn yellow, press MENU to save and exit. Only the "ok" turn yellow, it will save successfully when press MENU, otherwise, it will not save.
UMD Second Window Char	Setting is same as UMD Main Window Char. · xxxxxxxx Remark: This item shows in PIP.

Sub Menu	Description
Layout	[TSL3.1] Select TSL3.1. [TSL4.0] Select TSL4.0. [TSL5.0] Select TSL5.0. · TSL3.1 · TSL4.0 · TSL5.0
OSD Tally Mode	[OFF] Turn off OSD Tally. [RG] OSD Tally select RG mode. [GR] OSD Tally select GR mode. [RGY] OSD Tally select RGY mode. · OFF · RG · GR · RGY
LED Tally	Turn on/off the LED Tally. · ON · OFF
LED Tally Source	[GPI] Select GPI control. [TSL] Select TSL protocol control. · GPI · TSL

Alarm:

Main Menu	Alara
Status	Alara Display OFF
Function Key	No Signal Alara OFF
Picture	Black Frame Alara OFF
Image	Static Frame Alara OFF
Audio	Audio Mute Alara OFF
Marker	Audio Level High Alara OFF
Scope	Audio Level Low Alara OFF
Embedded code	EDH Error Alara OFF
Layout	CRC Error Alara OFF
IMD	
Alara	
Setup	
Key Lock	

Sub Menu	Description
Alarm Display	Turn off/on the alarm display. · Off · On
No Signal Alarm	Turn off/on the signal alarm. · Off · On
Black Frame Alarm	Turn off/on the black frame alarm. · Off · On

Sub Menu	Description
Static Frame Alarm	Turn off/on the static frame alarm. · Off · On
Audio Mute Alarm	Turn off/on the audio mute alarm. · Off · On
Audio Level High Alarm	Turn off/on the audio level high alarm. · Off · On
Audio Level Low Alarm	Turn off/on the audio level low alarm. · Off · On
EDH Error Alarm	Turn off/on the EDH error alarm. · Off · On
CRC Error Alarm	Turn off/on the CRC error alarm. · Off · On

Setup:

Main Menu	Setup
Status	Language English
Function Key	OSD Settings =>
Picture	Format Display Auto
Image	Power Saving ON
Audio	Screen Saver ON
Marker	Factory Reset <Right>to Factory Reset
Scope	
Embedded code	
Layout	
IMD	
Alara	
Setup	
Key Lock	

Sub Menu	Description
Language	Select Chinese/English in menu. · Chinese · English
OSD Settings	[Transparency 0-100] Menu background from opaque to completely transparent selection. [OSD Timeout 1-30] Menu disappear time when no button operation. [H Position 0-100] Menu horizontal position adjust. [V Position 0-100] Menu vertical position adjust. · Transparency 0-100 · OSD Timeout 1-30 · H Position 0-100 · V Position 0-100

Sub Menu	Description
Format Display	<p>[OFF] Turn off the display info of signal format. [ON] Turn on the display info of signal format. [Auto] Automatically display info of signal format when signal changes, disappear after 4s.</p> <ul style="list-style-type: none"> · OFF · ON · Auto
Power Saving	<p>Enter power-saving mode, the system will switch off some functions when the main input is without signal more than 10 minutes. This feature is invalid in PIP/PBP status.</p> <ul style="list-style-type: none"> · ON · OFF
Screen Saver	<p>The system will enter screen saver mode when the main input is without signal. This feature is invalid in PIP/PBP status.</p> <ul style="list-style-type: none"> · ON · OFF
Factory Reset	<p>Turn right the VOLUME knob, the system restore to factory setting.</p> <ul style="list-style-type: none"> · <Right> to Factory Reset

Key Lock:

Main Menu	Key Lock
Status	Key Lock OFF
Function Key	
Picture	
Image	
Audio	
Marker	
Scope	
Embedded code	
Layout	
IMD	
Alarm	
Setup	
Key Lock	

Sub Menu	Description
Key Lock	<p>[OFF] Key Lock Off.</p> <p>[ON] When the key lock is turn on, only MENU and VOLUME(LEFT/RIGHT) knob, IMAGEADJ(UP/DOWN) knob can be operate, the rest cannot.</p> <ul style="list-style-type: none"> · OFF · ON

3. Function Key

Function Key		
F1	Image Size	FILL ASPECT
F2	Marker Enable	OFF
F3	Audio Level Meter	OFF
F4	TimeCode Display	OFF
F5	Waveform Mode	OFF

Function Key	
Shortcut Menu	Set up/Description
F1	Press main menu Function key to set
F2	Press main menu Function key to set
F3	Press main menu Function key to set
F4	Press main menu Function key to set
F5	Press main menu Function key to set

Function Key Menu Operation Instructions

The Function key function can be set in the main menu. Press the function key to call up the function key menu and press the function key again to turn on / off the function. In the function key menu, use the IMAGEADJ (UP / DOWN) knob, you can also select the function key up / down. If the function key function contains a variety of modes, use the VOLUME (LEFT / RIGHT) knob, you can also quickly select the included other functions. For example, the F1 function key function on the figure is the image size, and the image size includes the following functions: original ratio, full screen, 1: 1, 16: 9, 4: 3 mode, use VOLUME (LEFT / RIGHT) You can quickly select the original ratio, full screen, 1: 1, 16: 9, 4: 3 in the Function key menu.

Dual picture operation

Continuous press PIP / PBP button, you can quickly from single-picture and dual-picture by the fast switch. In the dual picture, press the SWAP key, you can quickly exchange the left and right pictures. In the dual picture, press the WIN SEL button, you can select the picture window, at the same time, the selected window, you can also adjust the parameters alone, does not affect the other picture.

Pixel Measurements Operating Instructions

When you enter the pixel measurement function, rotate the VOLUME (LEFT / RIGHT) knob left / right or IMAGEADJ (UP / DOWN) knob up / down function, you can measure the large cross of the pixel measurement to move, you can measure any pixel Position and R, G, B values.

Use the pixel measurement function to compare two pixel contrast: When entering the pixel measurement function, rotate the VOLUME (LEFT / RIGHT) knob left / right or IMAGEADJ (UP / DOWN) knob up / down function to move the big cross to the first pixel, Press the VOLUME (LEFT / RIGHT) knob or the switch function of the IMAGEADJ (UP / DOWN) knob to mark the first pixel, and the pixel is marked with a small cross mark and then rotated VOLUME (LEFT / RIGHT) Knob on the left / right or IMAGEADJ (UP / DOWN) knob up / down function, then the operation will continue to move with a large cross, when the big cross standard to move you to the need to compare another pixel, You can compare the difference between the current pixel and the previous marker pixel.

Measure	Line	Sample	Y	Y%	Cb	Cr	R256	G256	B256
Current									
Ref-pos									
Diff									

Sub Menu	Description
Measure	Measure.
Current	Current pixel.
Ref-pos	Previous markup pixels.
Diff	The difference between the current pixel and the previous pixel.

Sub Menu	Description
Line	The vertical position of the pixel.
Sample	The horizontal position of the pixel.
Y	The Y component value of the pixel (range between 0-1023)
Y%	The percentage of the Y component of the pixel relative to the maximum, i.e., (Y component value / 256) * 100%
Cb	The blue chroma component of the pixel.
Cr	The red color component of the pixel.
R	The red component value of the pixel (range between 0-255).
G	The green component value of the pixel (range between 0-255)
B	The blue component value of the pixel (range between 0-255)

SDI 2K Signal Display Description

SDI in the 2K signal, the signal beyond the screen display, so look at the part of the image, you need the following operations:

1. Press the SWAP / 1: 1 button, the image is set to 1: 1 display.
2. Rotate the VOLUME (LEFT / RIGHT) knob, you can move the screen left and right, so you can view the screen beyond the screen display.

Factory Reset

This function is to reset the monitor to factory preset. Please try to reset the monitor, when the following situations occur:

1. The monitor parameters are adjusted incorrect by user.
2. The monitor picture or sound is abnormal, and not due to hardware problem.

To do factory reset, please follow the below five steps:

Main Menu	Setup
Status	Language English
Function Key	OSD Settings =>
Picture	Format Display Auto
Image	Power Saving ON
Audio	Screen Saver ON
Marker	Factory Reset <Right>to Factory Reset
Scope	
Embedded code	
Layout	
IMD	
Alara	
Setup	
Key Lock	

1. Press MENU button to enter main menu.
2. Turn VOLUME knob to item Setup and select it.
3. Turn IMAGE ADJ knob to Factory Reset and select it.
4. The screen will refresh after following the instruction of turning the VOLUME knob.
5. Power off the monitor, and must wait for at least 5 seconds, then restart the monitor. The monitor resets to factory preset.

Remote Control

Remote control the monitor through Ethernet:

1. Connected with monitor via LAN, and you can achieve remote controlling by software "Konvision Device Controller". (Network remote control software and instructions please contact with the dealer)
2. The LAN cable should be parallel connection for both two ends, for example 568B LAN cable, with pin definition: orange-white, orange, green-white, blue, blue-white, green, brown-white, brown.

Rack quick installation process

1. See Figure 1, when the pull-type monitor is fully folded, press the front two white screws tighten at the same time, the monitor can be fixed, so installed in the slide screen will not slide out. When the pull-up monitor is fully folded, its height H1 is 1U high and

the width W is the standard 19-inch rack-mounting width, with four screw holes on each of the front and rear sides to secure the machine stand, while the L length is Tune, the shortest is 470mm, the longest is 525mm.

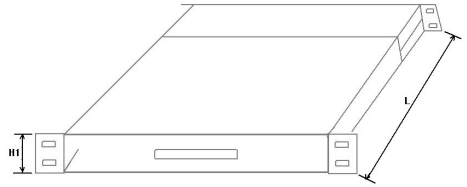

Figure 1

2. See Figure 2, when the pull-out monitor is pulled out horizontally, its extracted length L2 is 330mm.

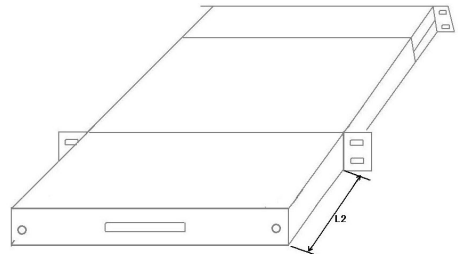
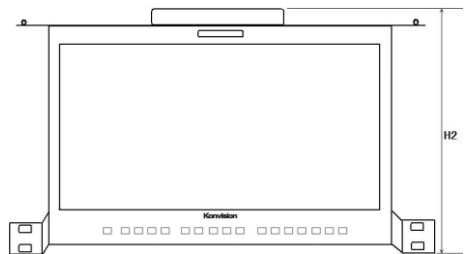

Figure 2

3. See Figure 3, when the pull-out monitor stands up, its height H2 is 312mm.



WARRANTY CARD

No

User			
Tel			
Address		Postal Code	
Model. No		Serial Number	
Warranty Date		Purchase Date	

Item	Contents of Reparation	Replacement parts name	Replacement parts quantity	Remark
1				
2				
3				
4				
5				
6				
7				
8				
9				
10				
11				
12				
13				
14				
15				

Repairer Signature	Service hotline	User Signature

